

RUA: CARMINO PIETRARRÓIA, PRAÇA Jácomo Langona

LOCALIZAÇÃO S/ESC.

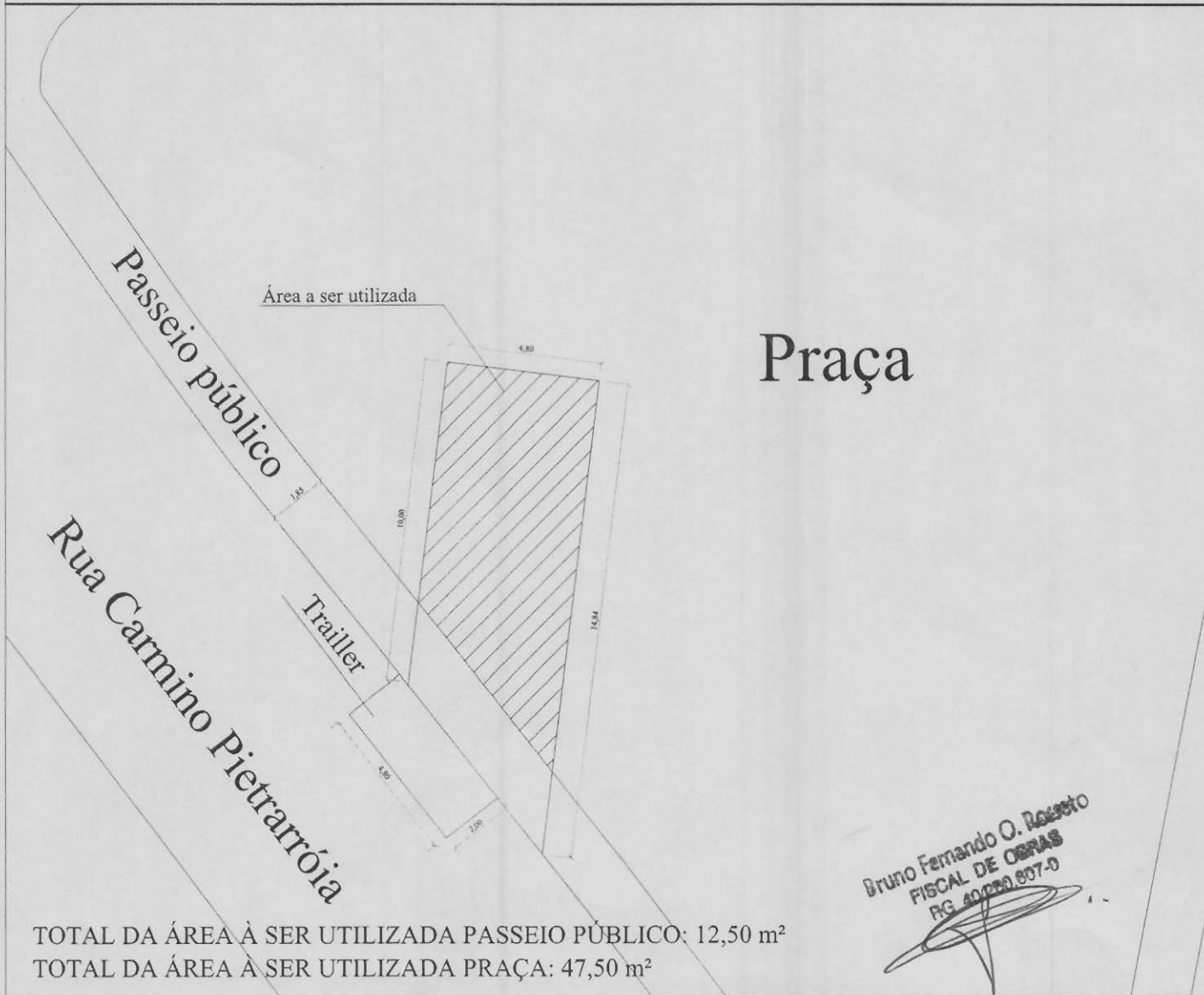
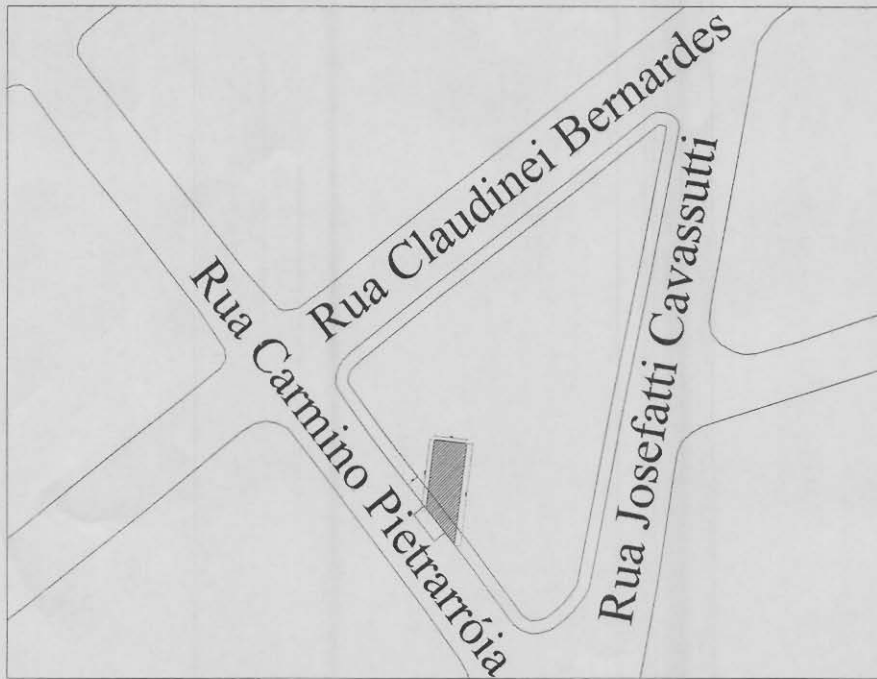

Praça

TOTAL DA ÁREA À SER UTILIZADA PASSEIO PÚBLICO: 12,50 m²
TOTAL DA ÁREA À SER UTILIZADA PRAÇA: 47,50 m²

Bruno Fernando O. Ribeiro
FISCAL DE OBRAS
RG 40.220.897-9

RUA: ANTONIO ESPERÂNDIO FERRARI, PRAÇA Henrique Ferrari

LOCALIZAÇÃO S/ESC.

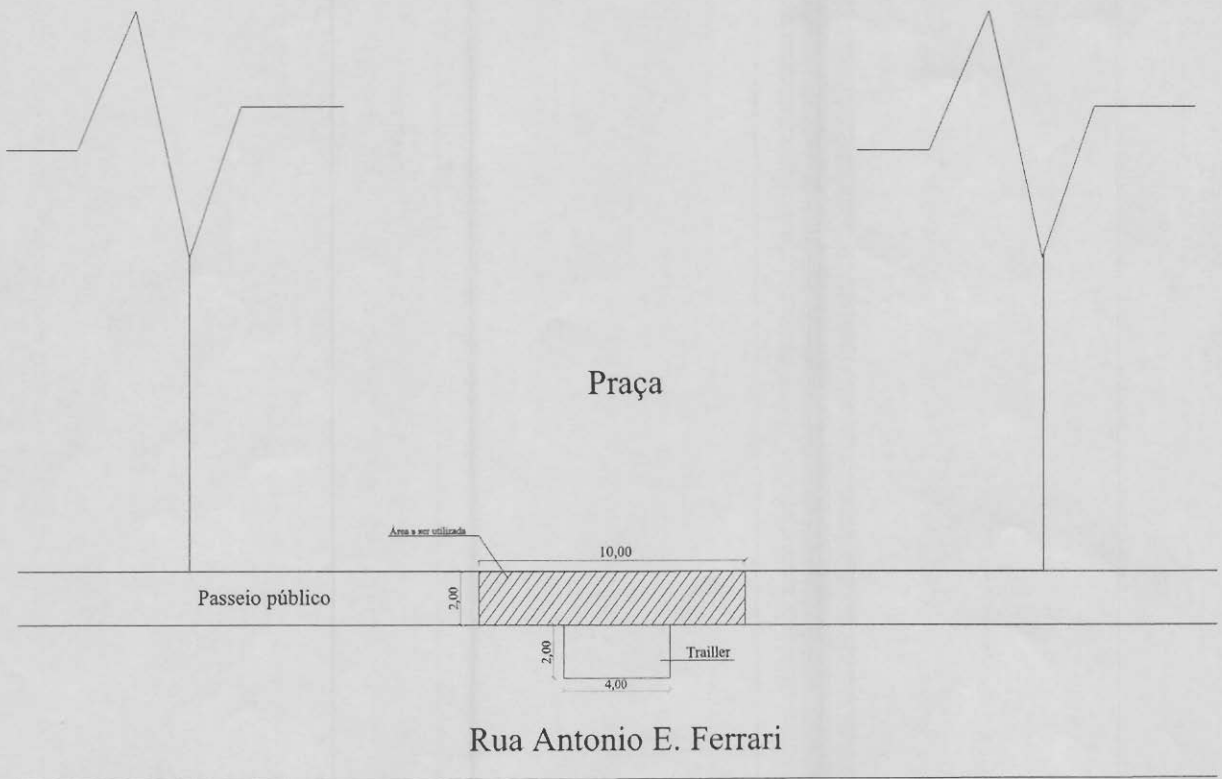
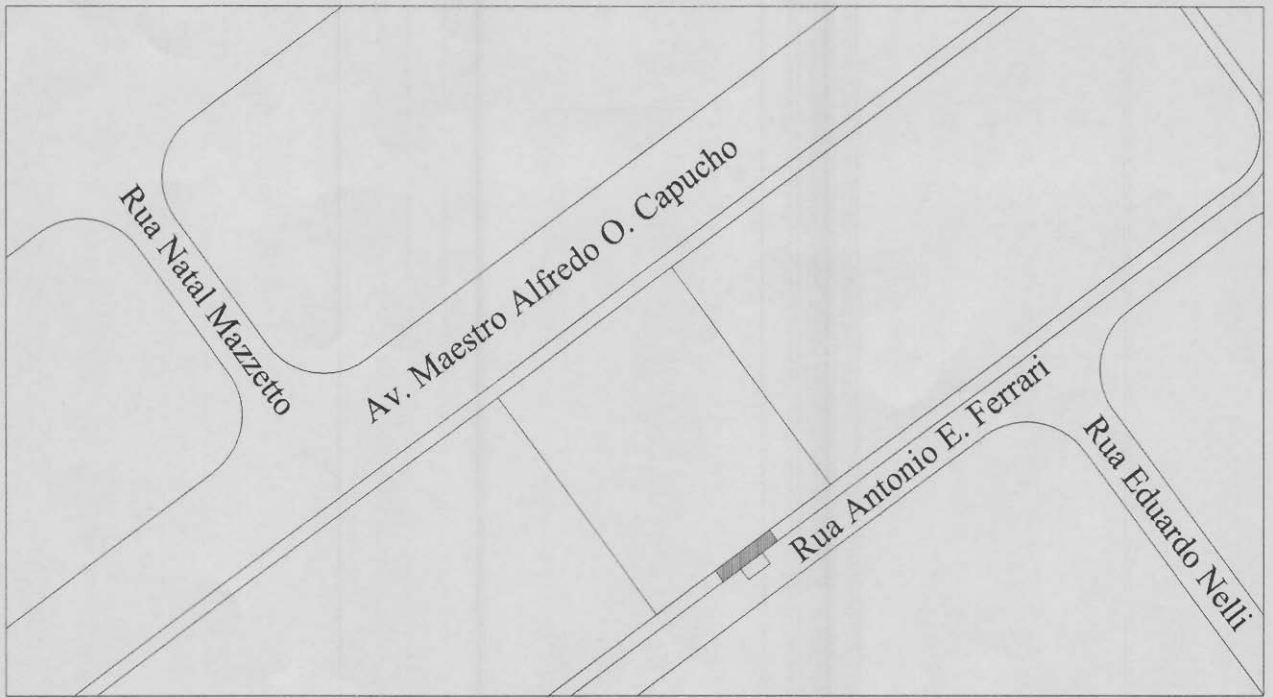

TOTAL DA ÁREA À SER UTILIZADA: 20,00 m²

Fernando O. Rosseto
FISCAL DE OBRAS
10-200-807-0

RUA: ANGELO ZACHARIAS, PRAÇA Jácomo Langona

LOCALIZAÇÃO S/ESC.

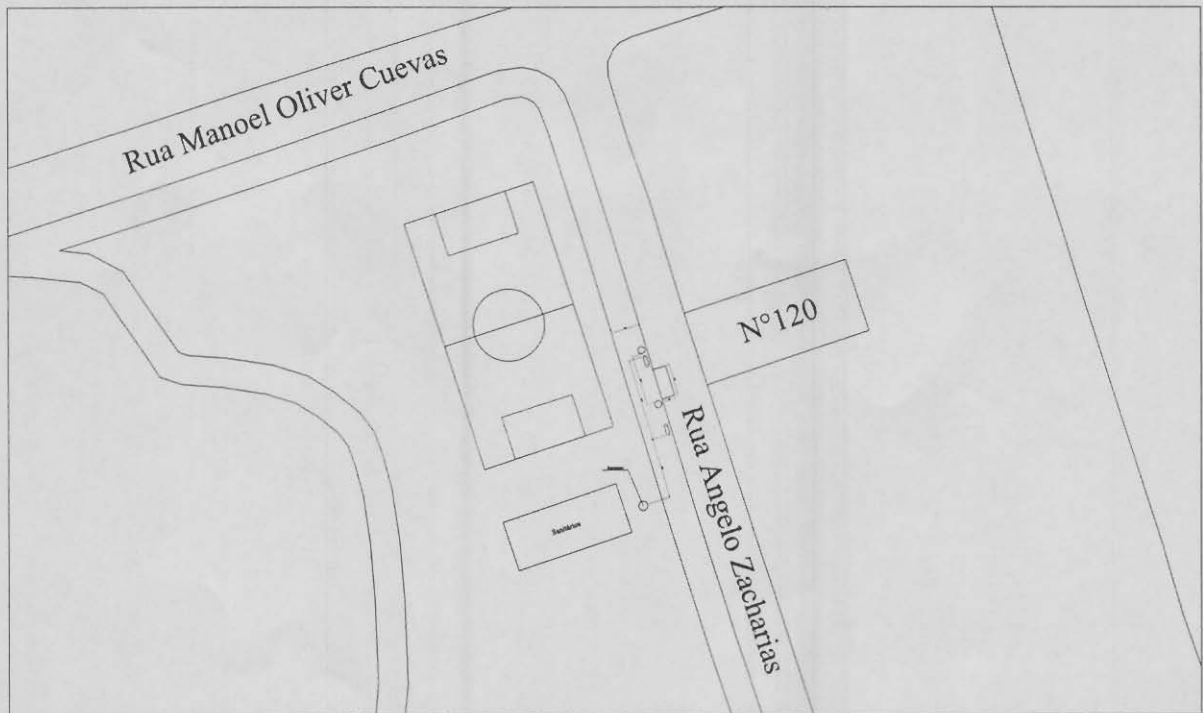

N°120

Bruno Fernando O. Rosseto
FISCAL DE OBRAS
RG 40.200.807-0

Rua Angelo Zacharias

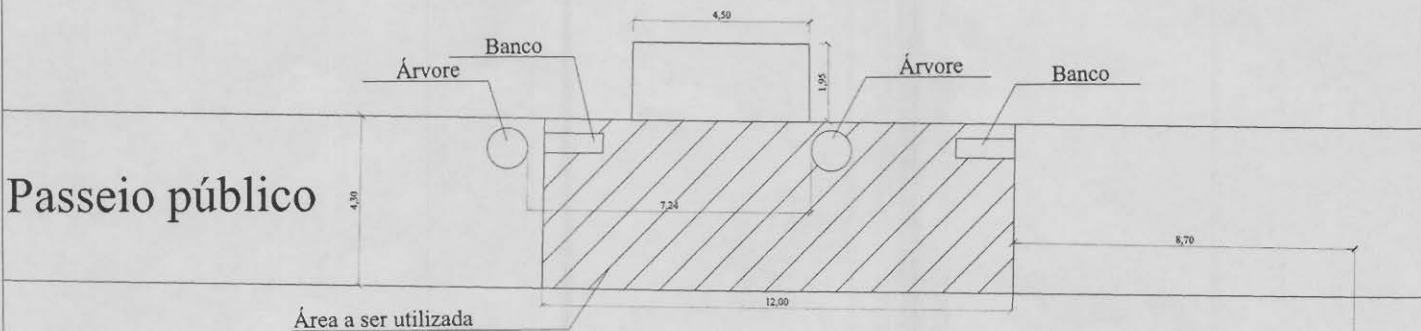

Bebedouro

Sanitários

TOTAL DA ÁREA À SER UTILIZADA: 51,60 m²

LOCALIZAÇÃO S/ESC.

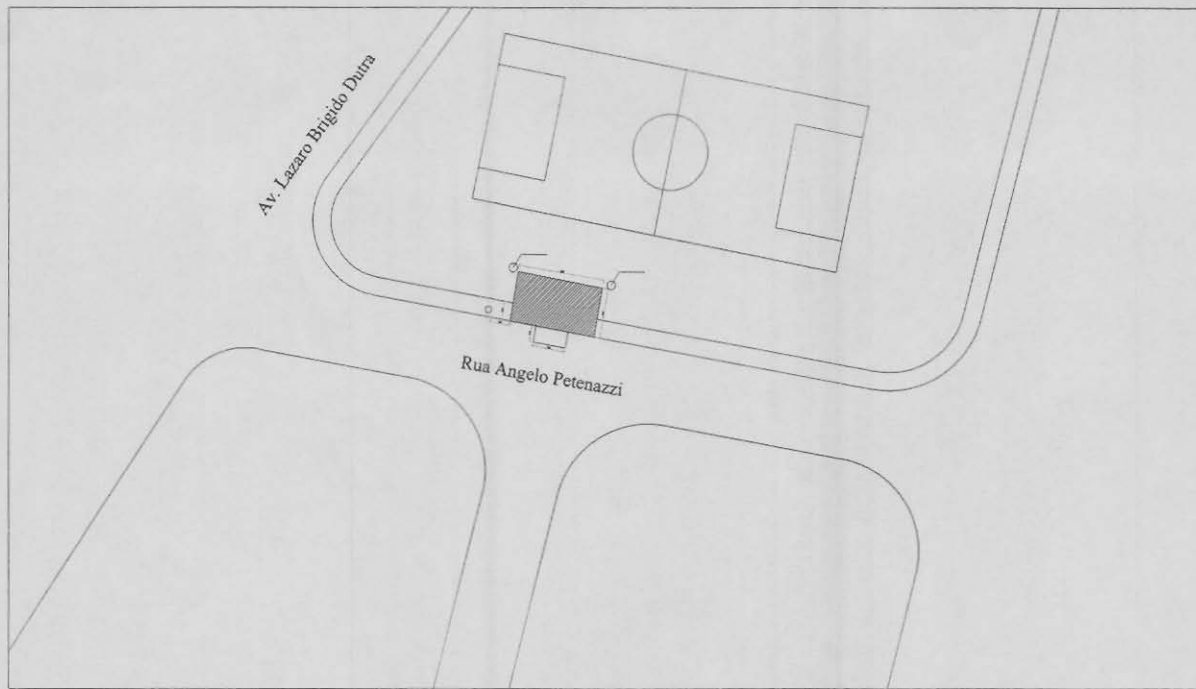

Praça



Rua Angelo Petenazzi

Nº17

Engenheiro Fernando O. Rosseto
FISCAL DE OBRAS
RG 40.200.837-0

LOCALIZAÇÃO S/ESC.

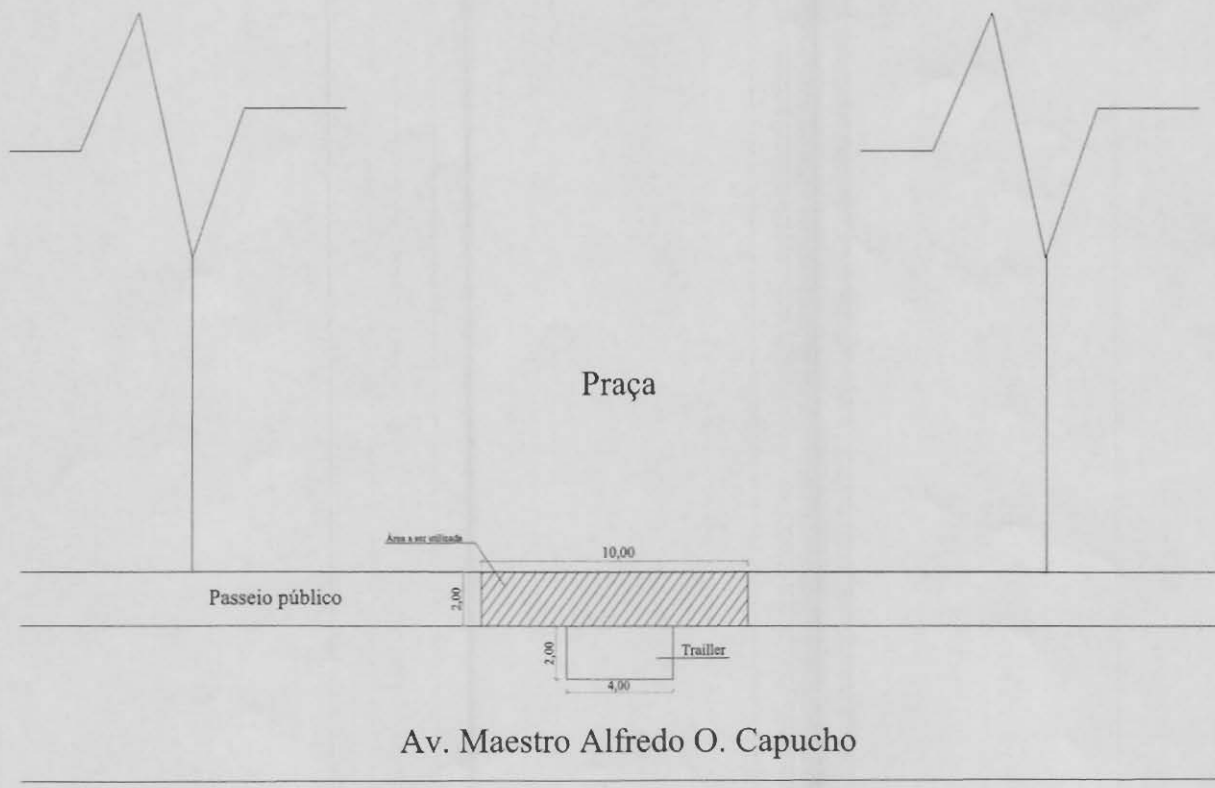

TOTAL DA ÁREA À SER UTILIZADA: 20,00 m²

Bruno Fernando O. Rosseto
FISCAL DE OBRAS
RG. 40.200.807.5

LOCALIZAÇÃO S/ESC.



Rua Angelo Lazari

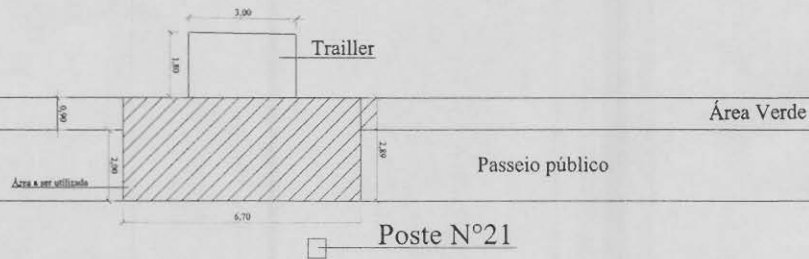

Praça

runo fernando O. Rosseto
FISCAL DE OBRAS
RG. 40.200.8073

TOTAL DA ÁREA À SER UTILIZADA: 19,43 m²

RUA: BAHIA, PRAÇA Horácio Moretto

LOCALIZAÇÃO S/ESC.

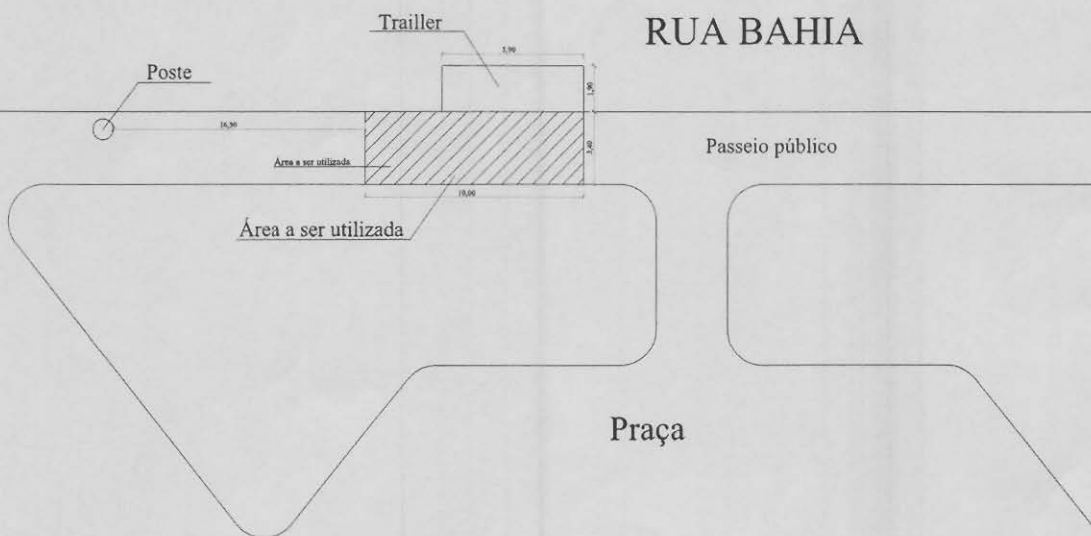
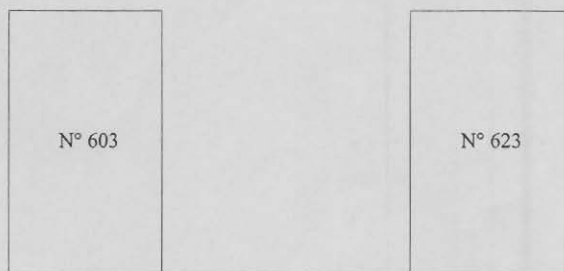
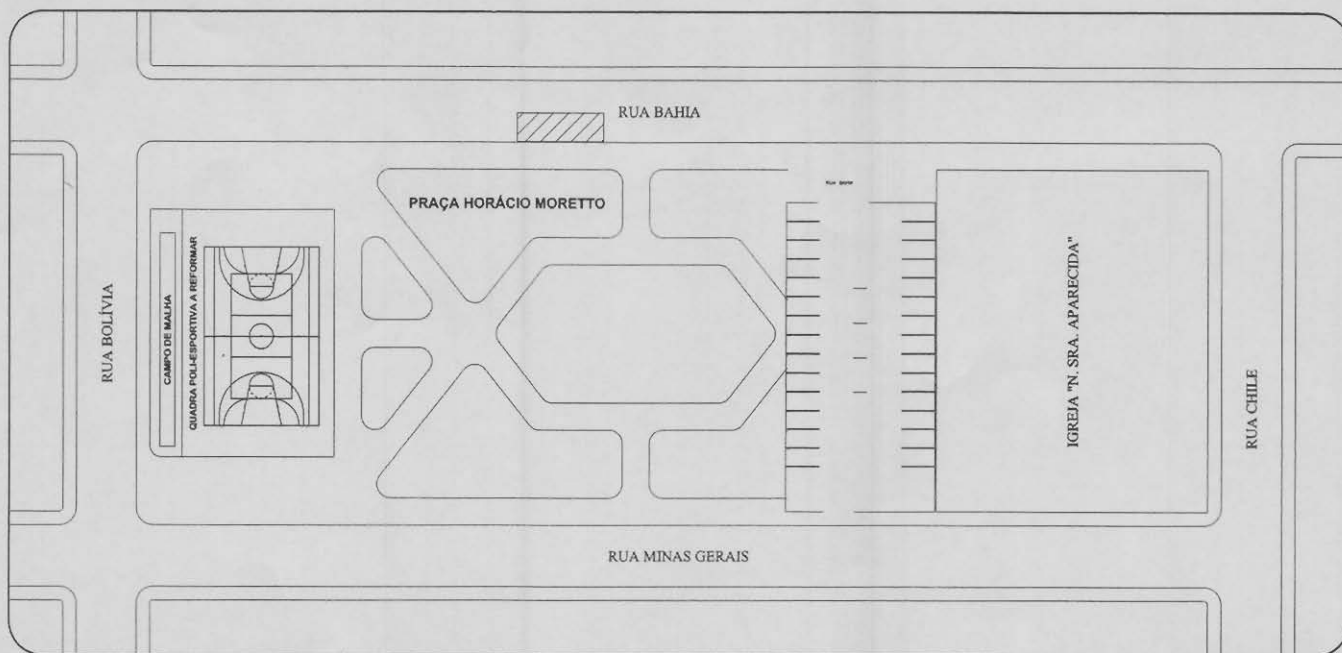

TOTAL DA ÁREA À SER UTILIZADA: 34,00 m²

Dr. Fernando M. Kossert
FISCAL DE GERAS
RG 40.200.6070

RUA: DOM PEDRO I, PRAÇA Bruno Brega

LOCALIZAÇÃO S/ESC.

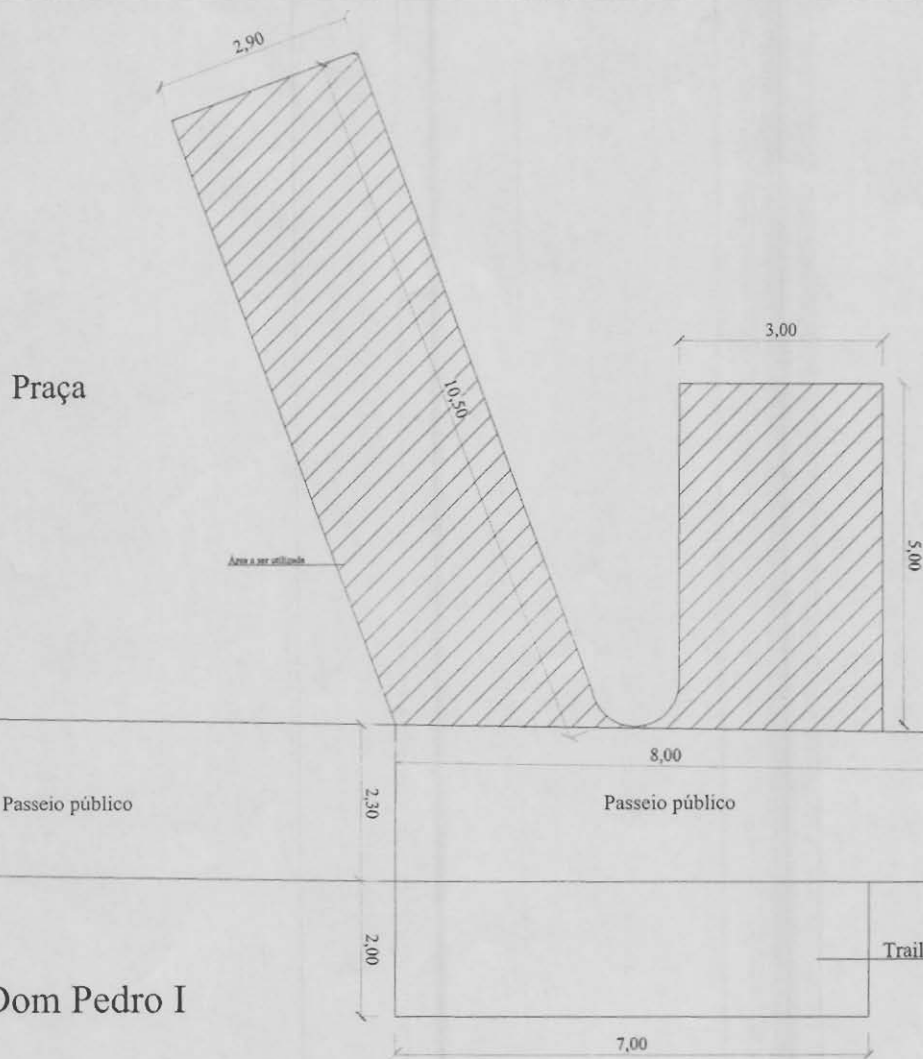
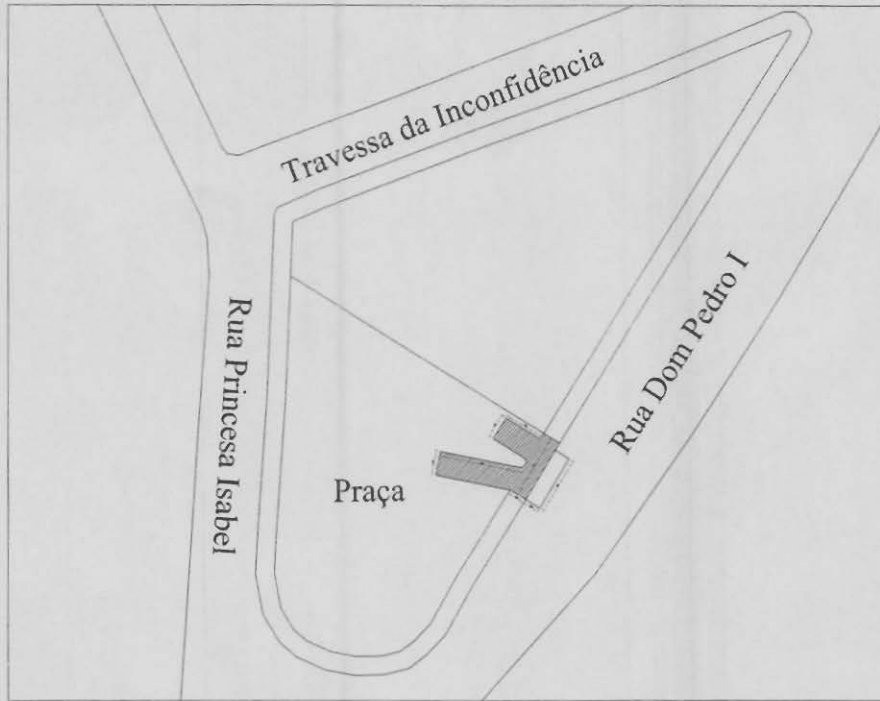

TOTAL DA ÁREA À SER UTILIZADA PRAÇA: 45,45 m² TOTAL DA ÁREA À SER UTILIZADA PASSEIO PÚBLICO: 18,40 m²

BRUNO FERNANDES G. ROSETO
FISCAL DE OBRAS
RG 49.260.897-0

RUA: EDILIO CARANI, PRAÇA das Nações

LOCALIZAÇÃO S/ESC.

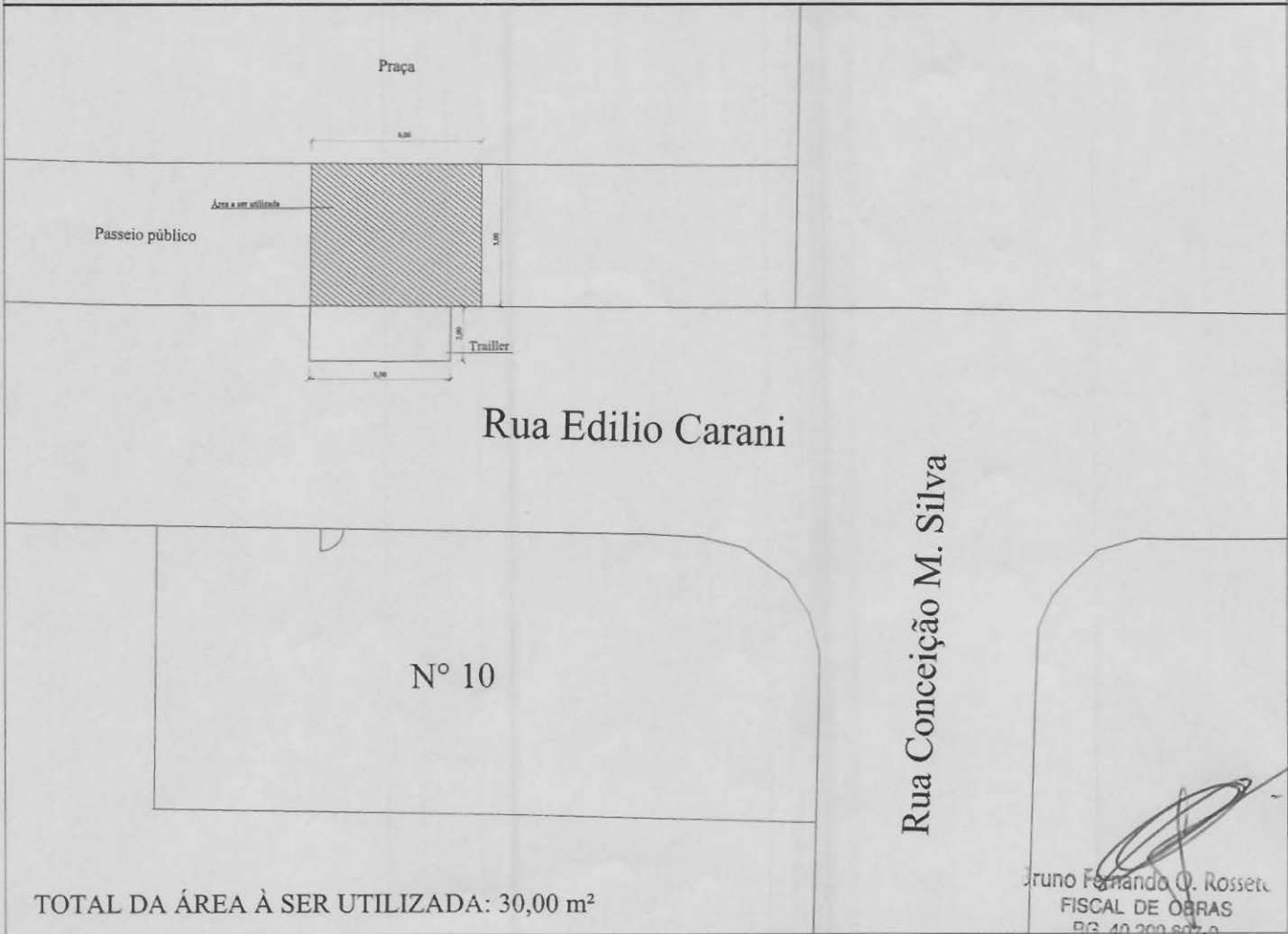
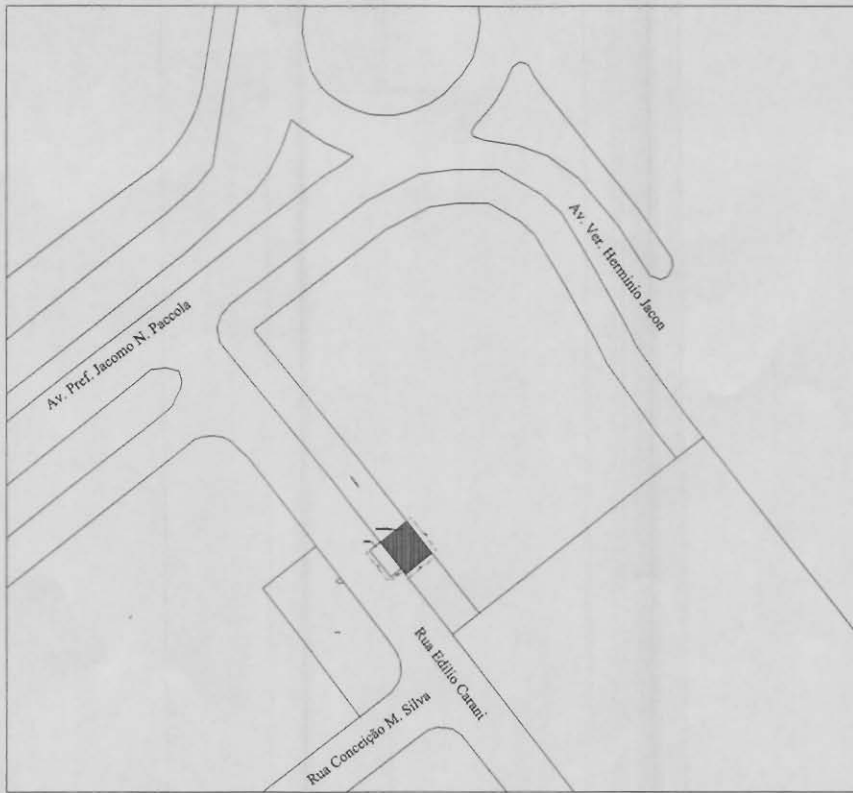

RUA: LUIZ BIRAL, PRAÇA Adelaide Souza Trindade Vasconcelos

LOCALIZAÇÃO S/ESC.



Rua Luiz Biral

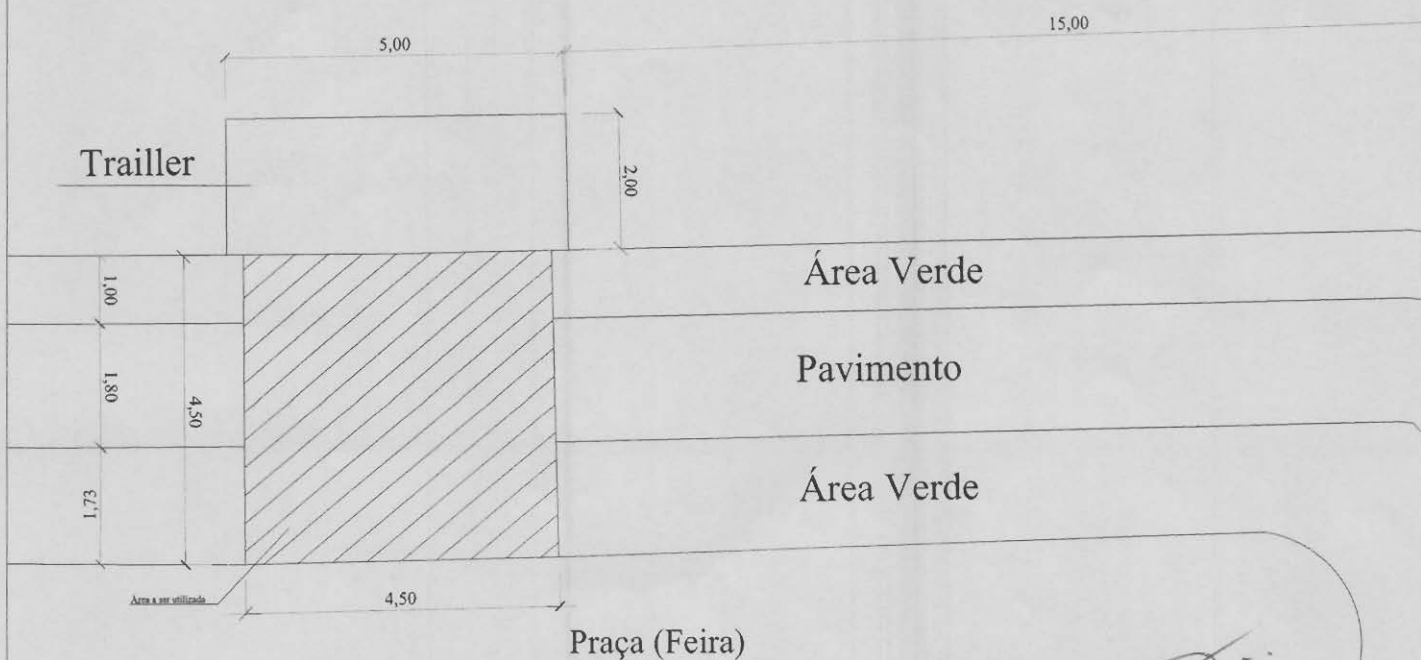

TOTAL DA ÁREA À SER UTILIZADA: 20,25 m²

Fernando O. Rosseto
FISCAL DE OBRAS
RG. 40.200.807-0

AV. ORÍGENES LESSA, PRAÇA Jefferson André da Silva

LOCALIZAÇÃO S/ESC.

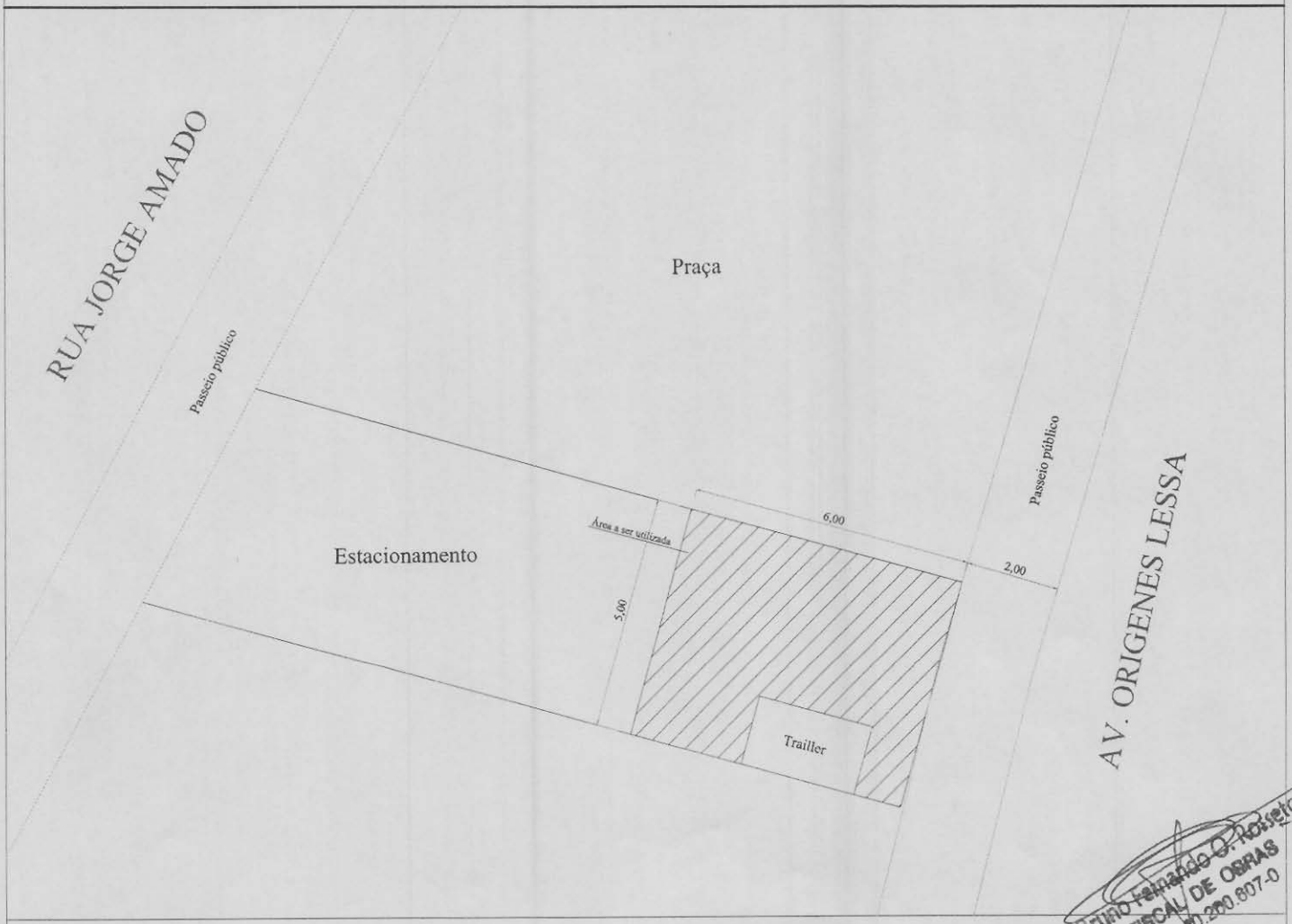
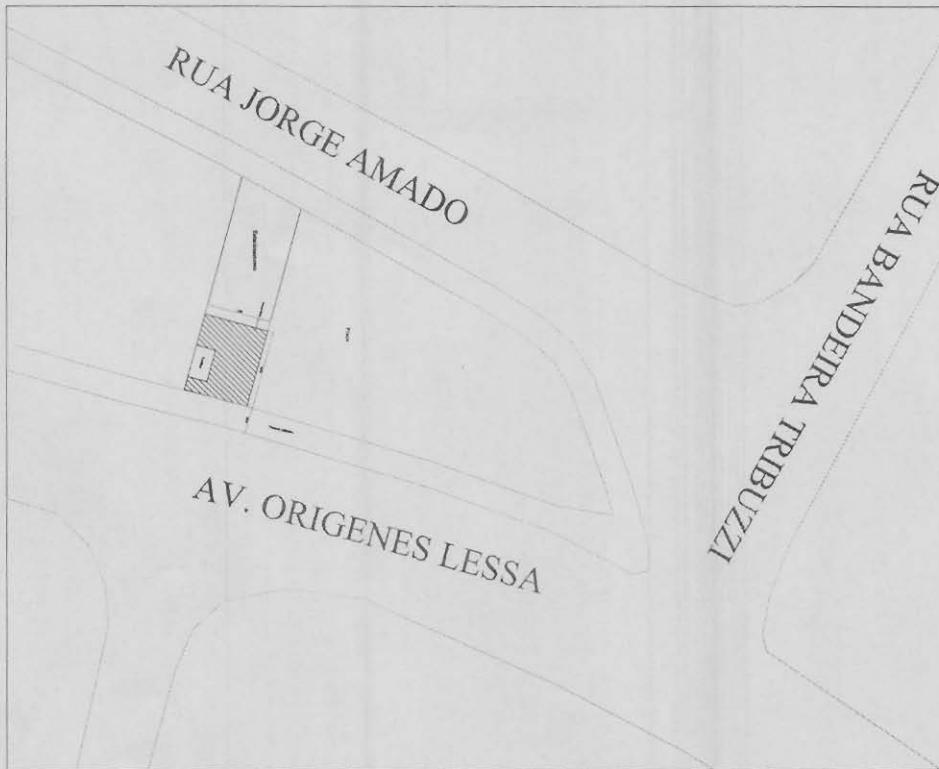

TOTAL DA ÁREA À SER UTILIZADA PRAÇA: 30,00 m²

Bruno Fernando C. Ribeiro
FISCAL DE OBRAS
RG Nº 200.807-0